



RE BEL SY STEM

Contemporaneità e dinamismo identificano un nuovo concetto di arredamento. La zona giorno si carica di nuovi significati e di un ritrovato carattere. L'estetica diventa funzionale, geometrie architettoniche si esaltano attraverso materiali grezzi, ruvidi, veri. Al di fuori dagli schemi, lontano dagli standard. Rebel System, la nuova collezione firmata FIMAR.

Contemporary styles and movement identify a new concept in furnishing. The living area takes on new meanings and a refound personality. The aesthetic becomes functional, architectural forms are enhanced through raw, rough, genuine materials. Out of the mould, far from the standard. This is Rebel System, the new collection by FIMAR.

Rebel System manifesta un' assoluta capacità di raccontare una modernità fatta di volumi in equilibrio, accostamenti di colore e materia ed effetti tridimensionali dati dalla Boiserie in legno dove le doghe sono posizionate a distanze diverse dal muro. Un progetto originale e brevettato, che diventa unico grazie alla particolarità delle finiture che lo caratterizzano.

Contemporary styles and movement identify a new concept in furnishing. The living area takes on new meanings and a refound personality. The aesthetic becomes functional, architectural forms are enhanced through raw, rough, genuine materials. Out of the mould, far from the standard. This is Rebel System, the new collection by FIMAR.



Partendo da materiali esistenti, ridando loro vita e valore, rispettando l'ambiente: così nasce Rebel System. Riciclare diventa la parola d'ordine. Il legno, derivante da vecchie cascine, il vetro ed il ferro che ricordano realtà industriali dismesse, materiali totalmente naturali come il compact a base di fibra di eucalipto. Materiali veri, abilmente trattati, che identificano il nuovo concetto della zona living dove natura ed ispirazione si declinano allo spazio abitativo.

Starting with existing materials, bringing them back to life and adding value, with eco friendliness: this is how Rebel System takes shape. The byword is recycle. The wood taken from old farmhouses, the glass and iron reminiscent of disused industrial buildings, totally natural materials such as the compact type made from eucalyptus fibres. Real materials, skilfully treated, which identify the new concept of the living area where nature and inspiration are structured according to the living space.



INDEX

pag. 60
COMPLEMENTI

01

pag. 07
LIVING 01

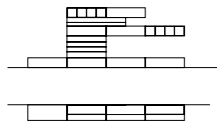

02

pag. 19
LIVING 02



03

pag. 30
LIVING 03

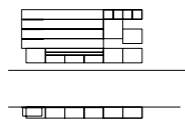

04

pag. 43
LIVING 04

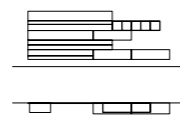

05

pag. 54
LIVING 05

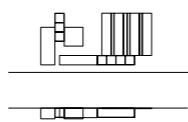

06

pag. 67
LIVING 06

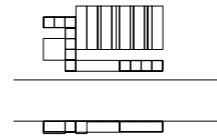

07

pag. 78
LIVING 07

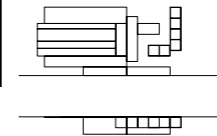

08

pag. 93
LIVING 08

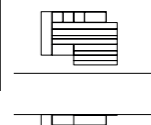

09

pag. 104
LIVING 09

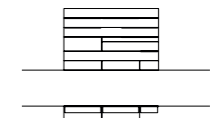



Cromie che richiamano
la dimensione naturale
si accompagnano
alla modernità e
all'essenzialità
del vetro e del ferro.
Una contrapposizione
unica ed affascinante.

*Colours referencing
the natural dimension
accompany the
modernity
and minimalism
of the glass and iron.
A unique and fascinating
juxtaposition.*

LIVING 01





Un sistema modulare,
con contenitori
in aggancio,
liberamente posizionabili.

*A modular system,
with linked storage units
which can be positioned
freely.*



Il sistema di moduli da cui è formata la libreria Edis, le permette di adattarsi alle geometrie della tua casa, in un gioco di pieni e vuoti in cui ogni elemento è il perfetto connubio di funzionalità ed estetica.

This system of modular elements creates a bookcase that is always proper to the layout of your home. Its relationship between solids and voids makes each part of it fully functional and utterly aesthetic.

LIVING 01





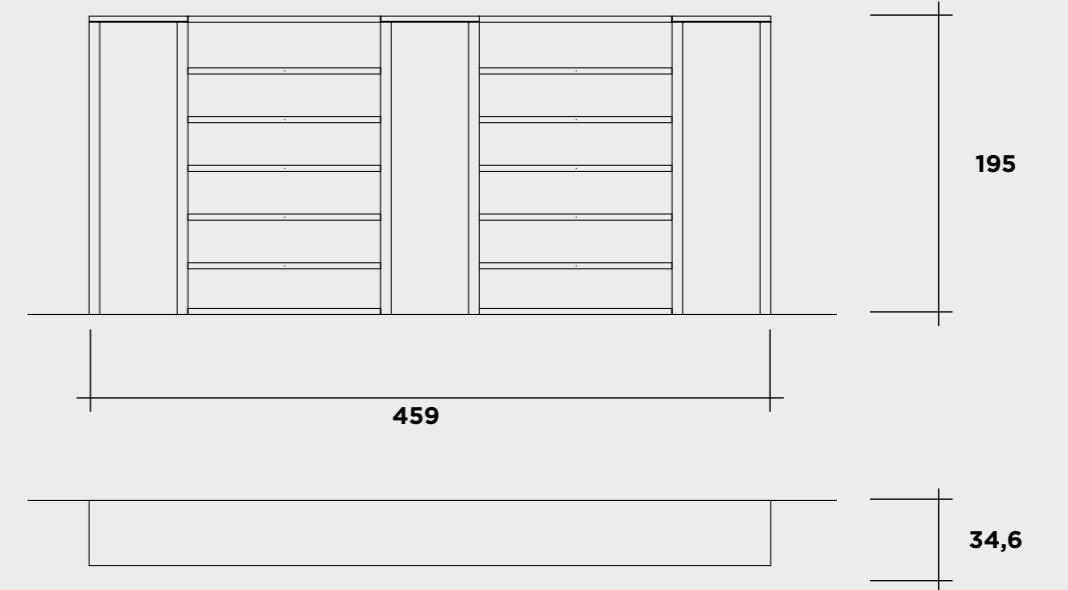
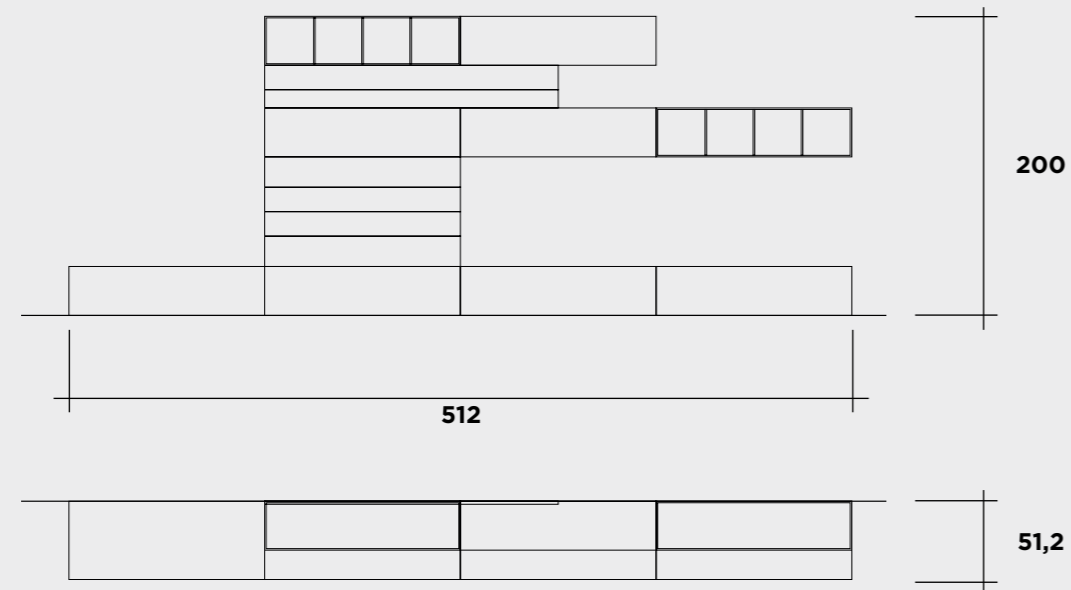

QUERCIA 75 G

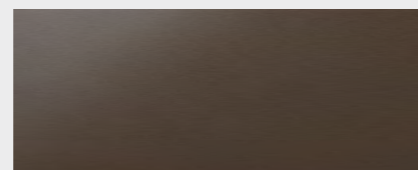

FERRO BRONZO



COMPACT CEMENTO

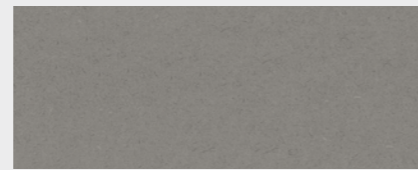

COMPACT CENERE

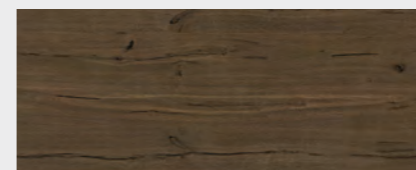

QUERCIA 75 G

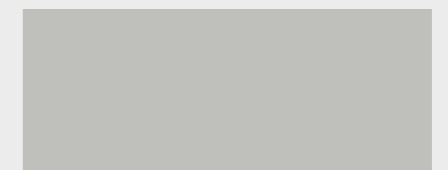

LACCATO GRANIT



LACCATO FUMO



Grafiche decorative
che nascono
dall'incontro di forme,
materiali, concetti,
idee e soluzioni.
Tutto racchiuso
in un unico punto.

*Decorative graphics
born of the coming
together of shapes,
materials, concepts,
ideas and solutions.
All this enclosed
in a single point.*

LIVING 02



Il sistema Rebel
si arricchisce di nuovi
elementi e finiture,
come l'anta in vetro
senza telaio per
esaltare la perfezione
di produzione
con trasparenze.

*The Rebel system
is enriched with new
elements and finishes,
like the glass door
without frame to
enhance production
perfection with
transparencies.*

LIVING 02







Una nuova collezione di madie e contenitori, composte da vani a giorno e contenitori con ante, contribuisce a creare uno spazio elegante e funzionale.

A new collection of cupboards and containers, composed of open compartments and containers with doors, helps to create an elegant and functional space.



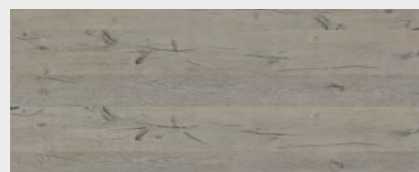
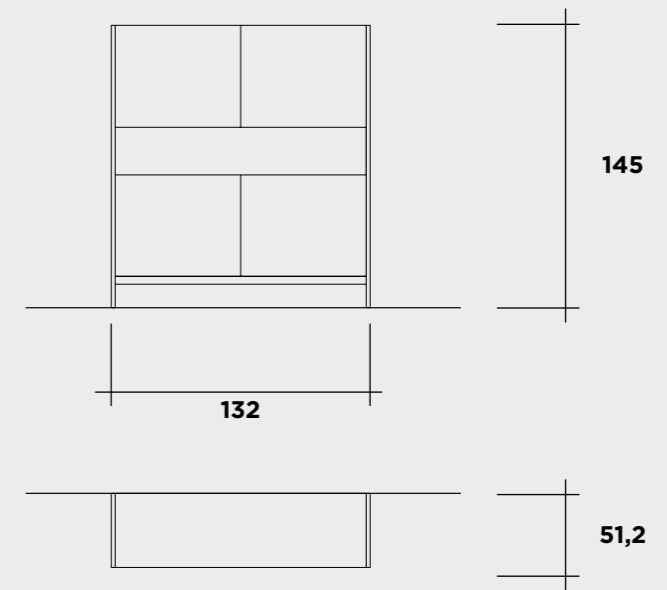
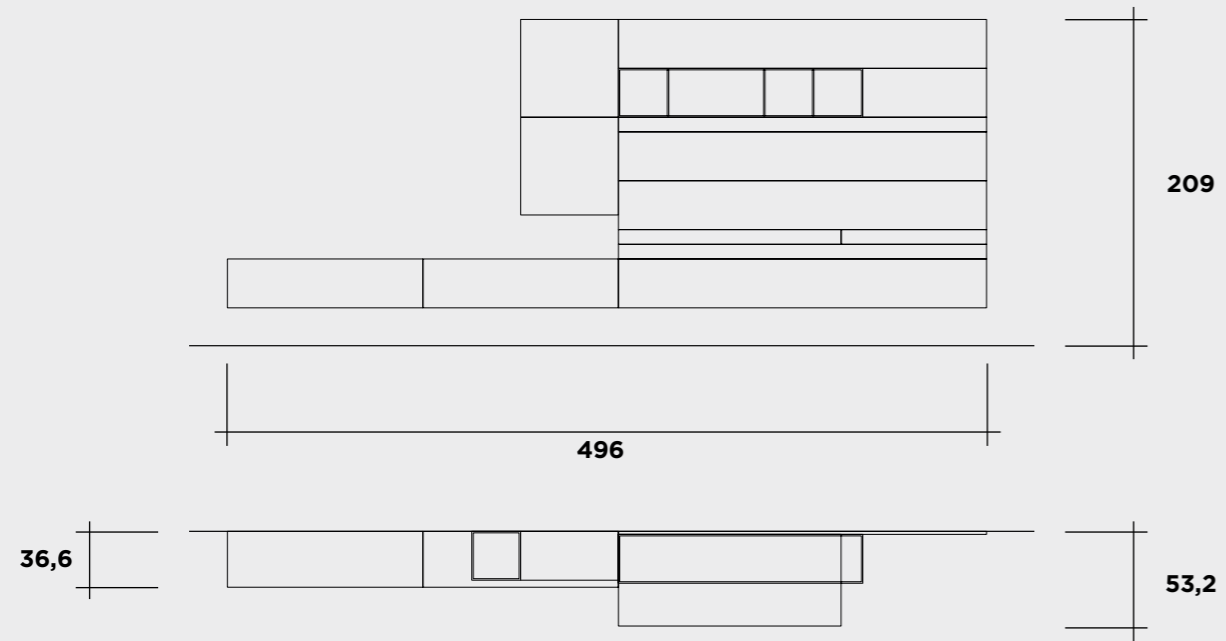

QUERCIA 50 C

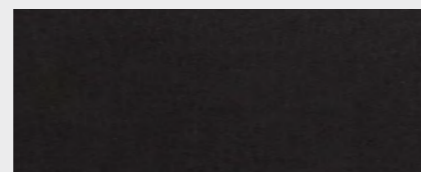

FERRO CERA

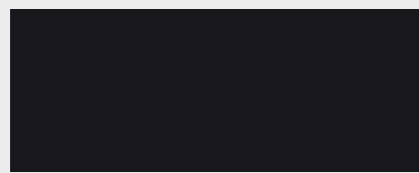

LACCATO ANTRACITE



LACCATO ARDESIA

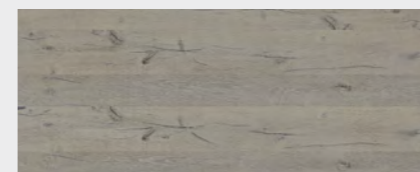

QUERCIA 50 C

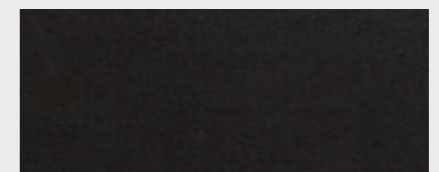

FERRO CERA



LACCATO ARDESIA

Il design si configura
attraverso il dinamismo
dei diversi elementi
e mediante l'impiego
di materiali differenti.

*The design is configured
through the dynamism
of the different elements
and through the use of
different materials.*

LIVING

03







La nuova contemporaneità scritta da Fimar, privilegia la particolarità dei materiali e la purezza del design.

The new contemporary style from Fimar, focuses on the special features of the materials and the clean lines of the design.

LIVING 03





Tv rack flag è la versione più minimalista dei porta tv orientabili Fimar. Un supporto metallico è assicurato alla boiserie.

Tv rack flag connect is the most minimalist version of the Fimar adjustable tv units. A metal support is secured to the wood panelling .

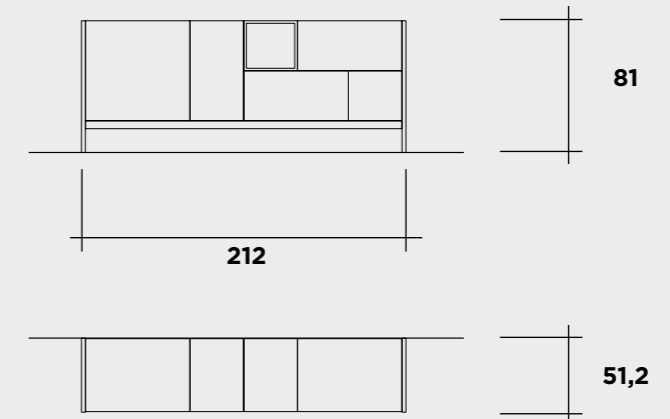
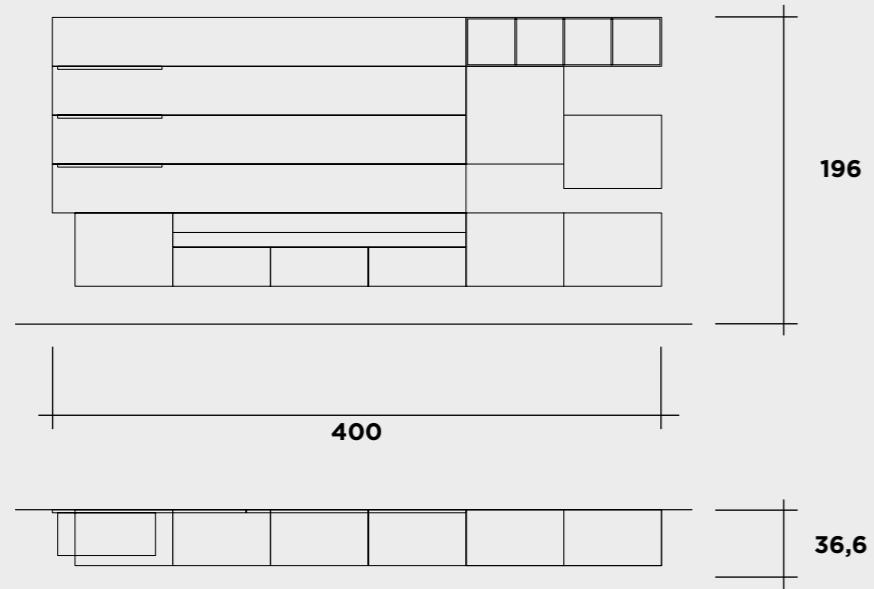

QUERCIA 75 G

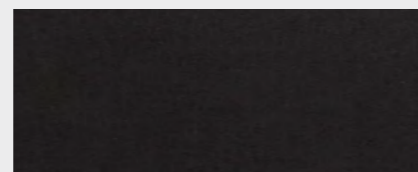

FERRO CERA

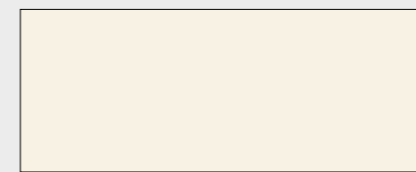

LACCATO GIGLIO

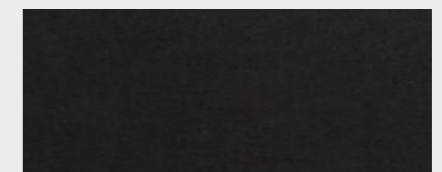

FERRO CERA



COMPACT CENERE

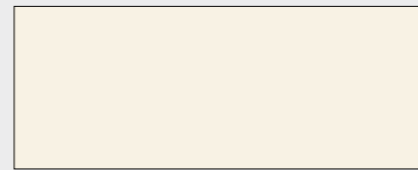

LACCATO GIGLIO

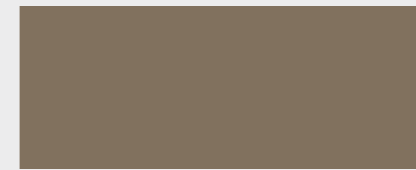

LACCATO TORTORA



Atmosfere cariche di eleganza contemporanea, dove l'eccesso non è contemplato, dove l'armonia tra forma e materia detta i canoni di una nuova estetica.

Moods filled with elegance, where excesses are never contemplated and where the harmony between form and material dictates the rules of a new aesthetic.

LIVING 04



L'evoluzione
del concetto di arredo
si esprime attraverso
la semplicità delle forme
combinare tra loro
per portare lo stile
al centro del progetto.

*The development on the
concept of furnishing is
expressed through
the simplicity of the shapes,
combined with each other
to bring style
to the centre of the design.*

LIVING 04







Il tavolo allungabile Rebel System esprime al meglio la capacità di caratterizzare gli spazi abitativi attraverso un approccio inedito, basato sulla volontà di creare ambienti unici, dove estetica e materiali definiscono nuovi percorsi d'arredo.

The Rebel System extendable table best expresses the ability to characterize living spaces through an unprecedented approach, based on the desire to create unique environments, where aesthetics and materials define new furnishing paths.



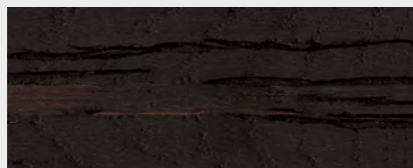
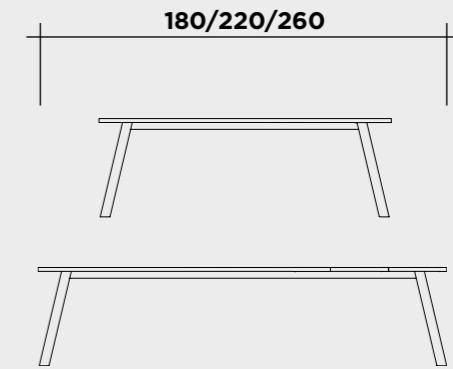
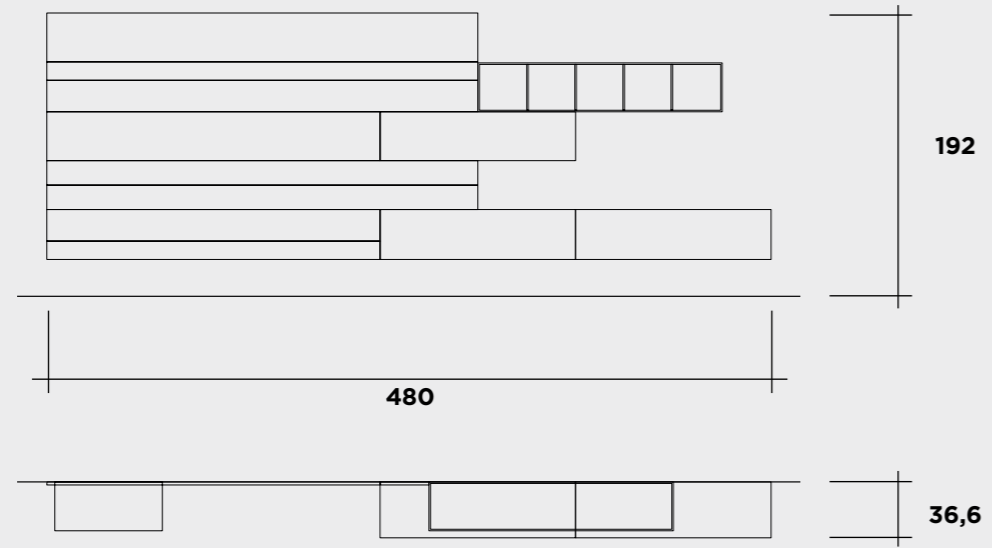

QUERCIA 25 G

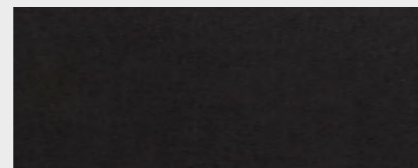

FERRO CERA

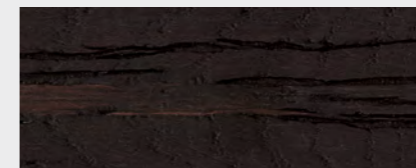

QUERCIA 25 G



LACCATO POMICE

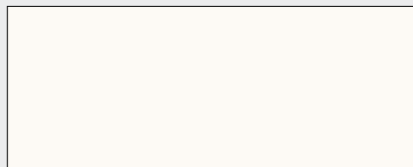

LACCATO INVERNO

Contesti abitativi, case che diventano portavoce di design, stile, passione e gusto. Ognuna di esse si racconta attraverso immagini di spazi studiati per il comfort dell'abitare.

Different living contexts, become representations of design, style, passion and taste. Each one tells its own story through images of spaces designed around living comfort.

LIVING

05







Cromie che richiamano
la dimensione naturale
si accompagnano
alla modernità e
all'essenzialità delle forme.
Una contrapposizione
unica ed affascinante.

*Chromie that recall
the natural size yes
accompany the
modernity and
essentiality of the forms.
A unique contrast
and fascinating.*



La nuova collezione di madie Rebel System, nasce dall'idea di interpretare eleganti contenitori per l'area living in forme inedite e originali. Un segno grafico deciso, superfici laccate opaco si alternano ad essenze di legno attribuendone un' identità ben precisa. La collezione di madie è perfettamente in sintonia estetica con tutti i prodotti Fimar, per creare un ecosistema ideale per la casa contemporanea.

The new collection of sideboards Rebel System, comes from the idea of interpreting elegant containers for the living area in new and original forms. A decisive graphic sign, matt lacquered surfaces alternate with wood essences, giving them a precise identity. The collection of sideboards is in perfect aesthetic harmony with all Fimar products, to create an ideal ecosystem for the contemporary home.

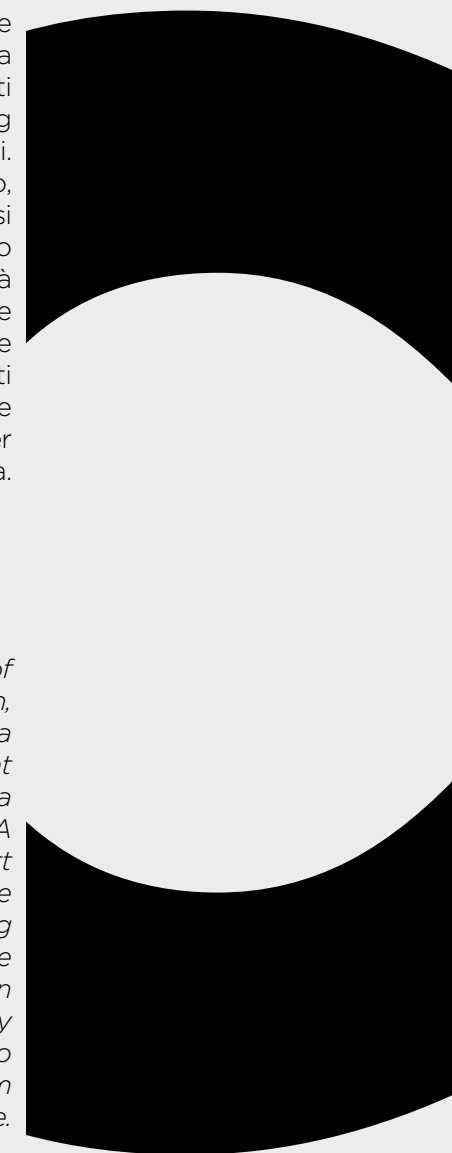

MADIA RS_01

Laccato Ardesia
Quercia 50
Struttura Ferro cera

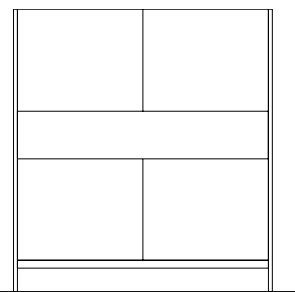

L.132 / H.145 / P.51,2



LACCATO ARDESIA

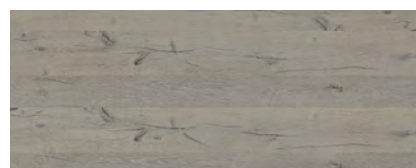

QUERCIA 50 C

MADIA RS_02

Laccato Sabbia
Noce Random
Struttura Ferro cera

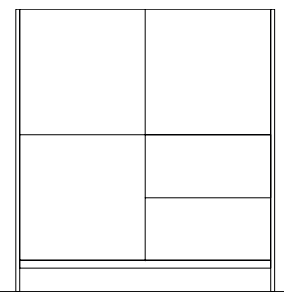

L.132 / H.145 / P.51,2

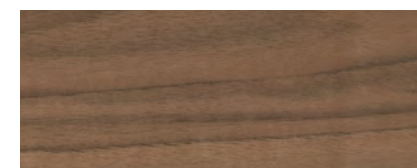

NOCE RANDOM



LACCATO SABBIA

MADIA RS_03

Laccato Giglio
Laccato Tortora
Laccato Metallico Bronzo
Struttura Ferro cera

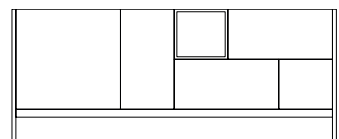

L.212 / H.81 / P.51,2

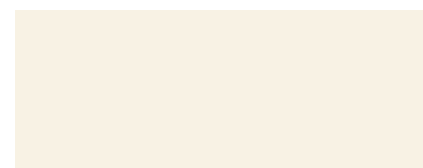

LACCATO GIGLIO



LACCATO TORTORA

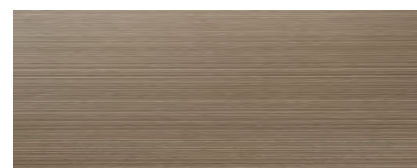

LACCATO METALLICO BRONZO

MADIA RS_04

Laccato Visone
Laccato Sabbia
Struttura Laccato metallico Bronzo

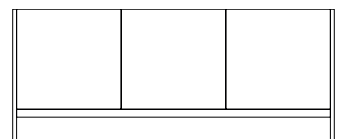

L.196 / H.81 / P.51,2



LACCATO VISONE



LACCATO SABBIA

MADIA RS_05

Compact Blu
Compact Cenere
Struttura Ferro cera

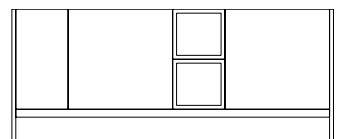

L.196 / H.81 / P.51,2

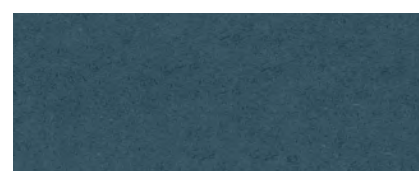

COMPACT BLU

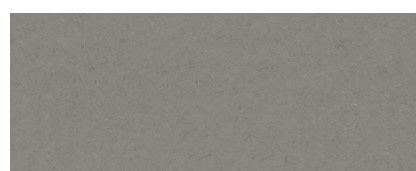

COMPACT CENERE

MADIA RS_06

Compact Cenere
Laccato Ferro
Struttura Ferro cera

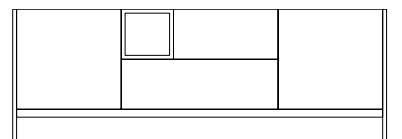

L.228 / H.81 / P.51,2

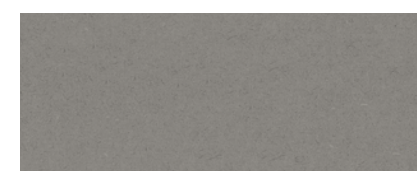

COMPACT CENERE



LACCATO FERRO

MADIA RS_07

Laccato Metallico Grafite
Laccato Latte
Struttura Ferro cera

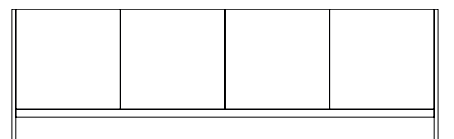

L.260 / H.81 / P.51,2

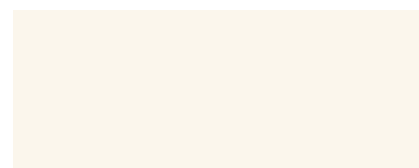

LACCATO LATTE

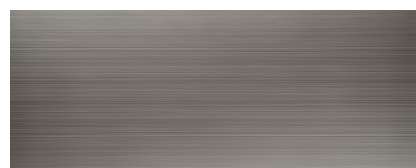

LACCATO METALLICO GRAFITE

MADIA RS_08

Olmo
Laccato Tortora
Struttura Laccato metallico Bronzo

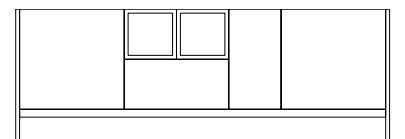

L.228 / H.81 / P.51,2



LACCATO TORTORA

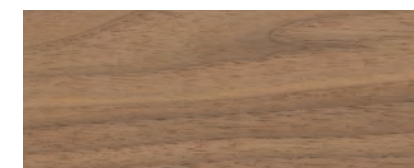

OLMO

MADIA RS_09

Eucalipto
Laccato Visone
Struttura Laccato metallico Bronzo

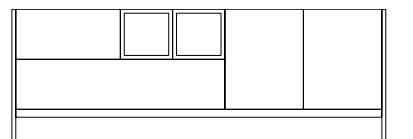

L.228 / H.81 / P.51,2

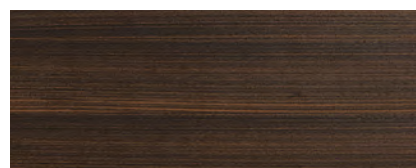

EUCALIPTO

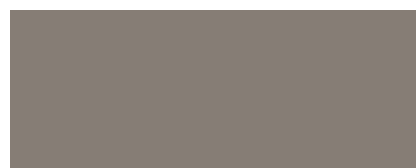

LACCATO VISONE

MADIA RS_10

Laccato Tortora
Laccato Giglio
Struttura Ferro cera

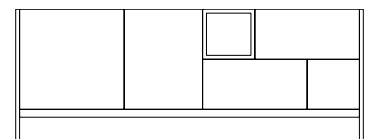

L.212 / H.81 / P.51,2



LACCATO TORTORA

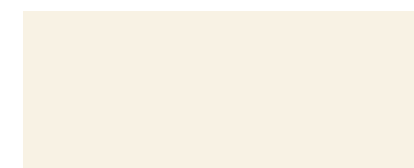

LACCATO GIGLIO

SEDIA META

Laccato Avio
Laccato Pietra
Laccato Latte

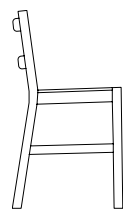

LACCATO AVIO



LACCATO PIETRA

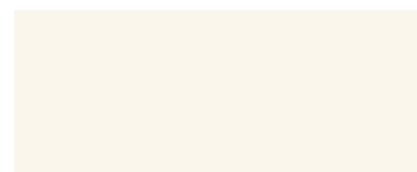

LACCATO LATTE

SEDIA SINUA

Laccato Caffè poro aperto

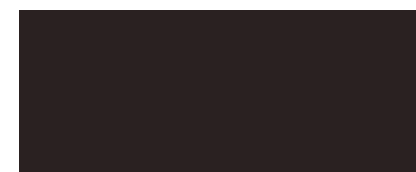

LACCATO CAFFÈ PORO APERTO

TAVOLINO REBEL

Quercia 25 / ferro cera
Olmo / laccato metallico bronzo
Noce random / laccato metallico bronzo



L.64/96/128 / H.32 / P.64



QUERCIA 25 S

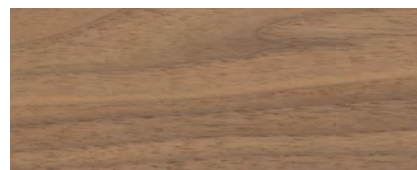

OLMO



NOCE RANDOM

TAVOLO REBEL

Quercia 25 / ferro cera

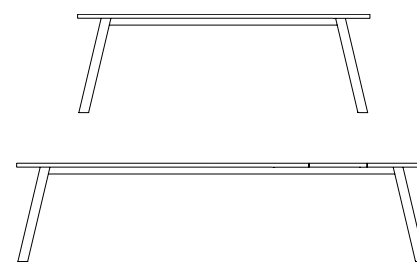

L.180 +40+40 / H.73 / P.90



QUERCIA 25 S

Finiture di pregio
e lavorazioni
tecnicamente avanzate
caratterizzano
ogni elemento, fino al
più piccolo dettaglio.

*Fine finishes and
technically advanced
manufacturing
characterize each
element, down to the
smallest detail.*

LIVING

05



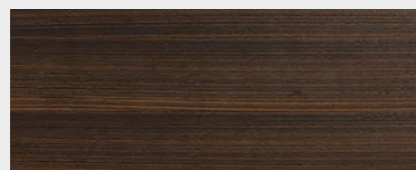
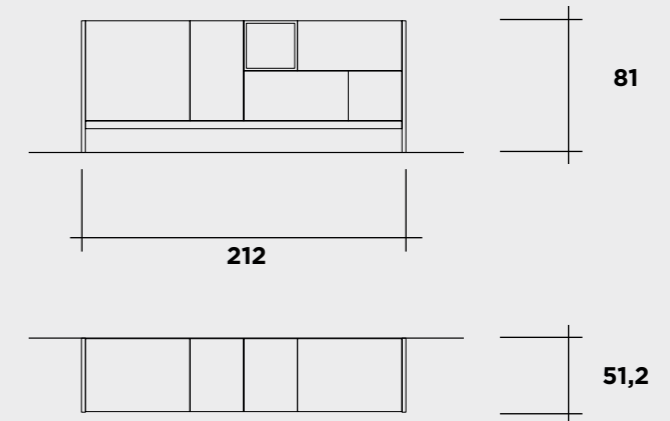
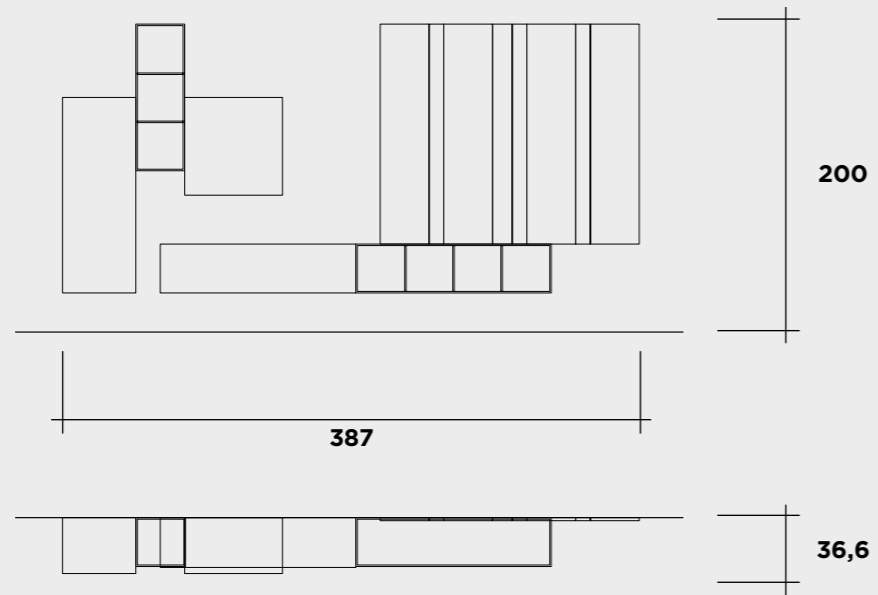

EUCALIPTO

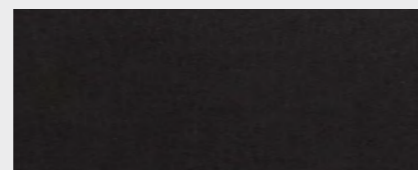

FERRO CERA

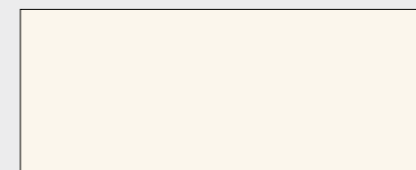

LACCATO LATTE

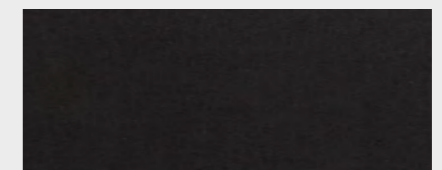

FERRO CERA

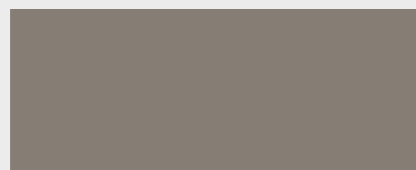

LACCATO VISIONE

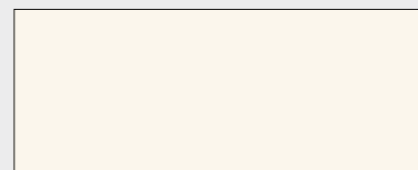

LACCATO LATTE

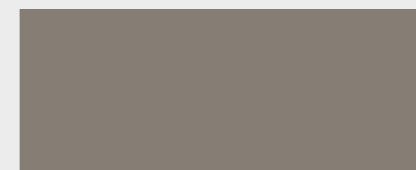

LACCATO VISIONE



Architetture essenziali
in un gioco di pieni
e vuoti in perfetta
armonia tra loro.
È questo lo spirito
progettuale del nuovo
Rebel System.

*Essential architecture
where solid and empty
volumes create perfect
harmony.
This is the spirit
of the new
Rebel System.*

LIVING 06



Il progetto libreria a fianco portante è un programma mixato per libere aggregazioni polifunzionali. Non solo libreria moderna, ma anche spazi a contenere e zone altamente specialistiche e dinamiche.

The supporting side bookcase project is a mixed program for free multifunctional aggregations. Not only a modern bookcase, but also storage spaces and highly specialized and dynamic areas.

LIVING 06





Le ante a spessori variabili si alternano in un gioco di linee, di pieni e vuoti, che rendono l'ambiente unico nel suo genere, con anche la possibilità di avere gli elementi a giorno con luce LED integrata.

The doors with variable thickness alternate in a game of lines, of empty and full, which make the environment unique of its kind, with the possibility of having the open elements with integrated LED light.





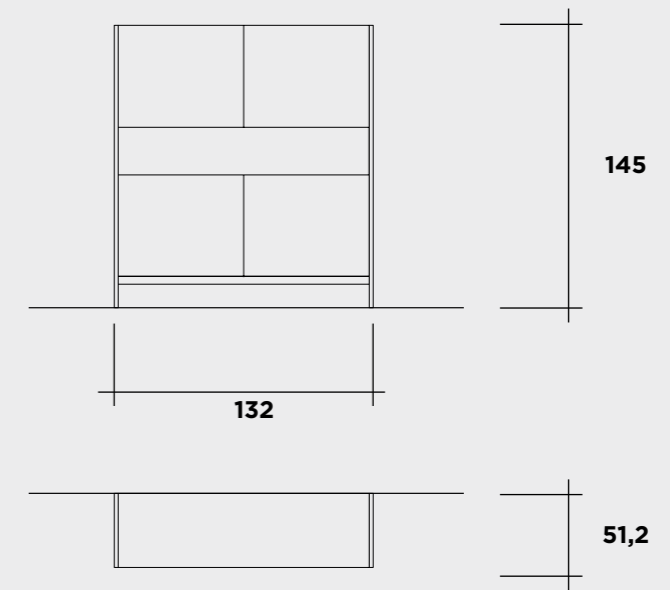
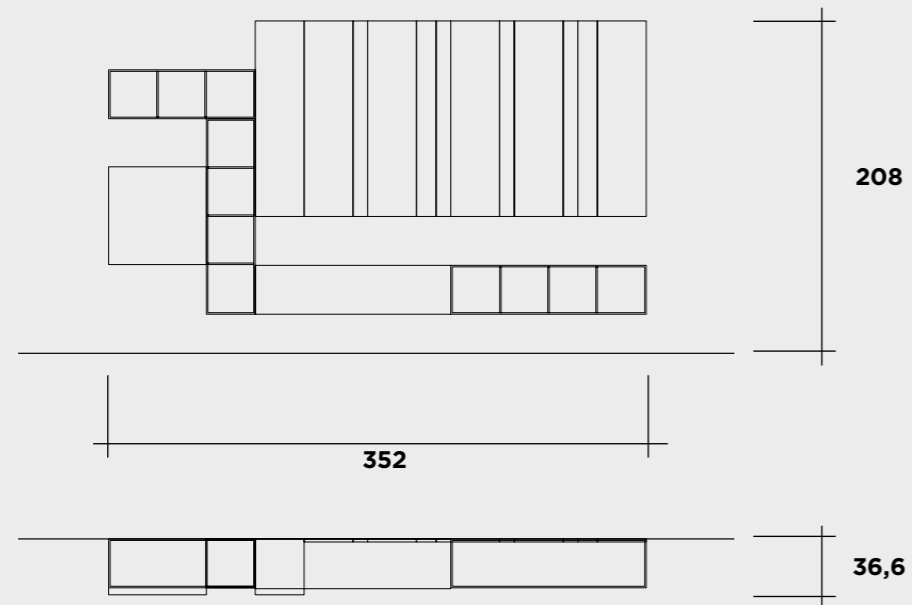

OLMO RAME

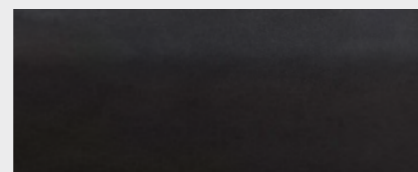

FERRO CERA

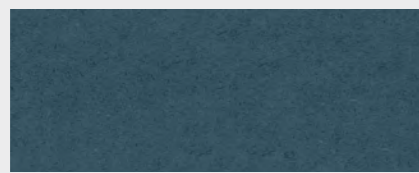

COMPACT BLU

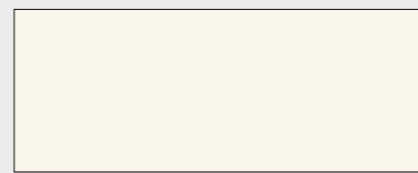

LACCATO LATTE



OLMO RAME

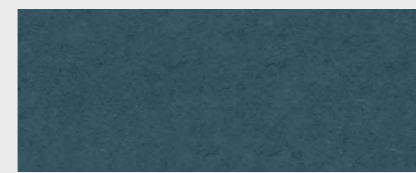

COMPACT BLU

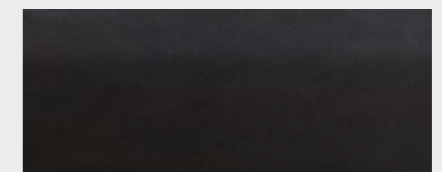

FERRO CERA

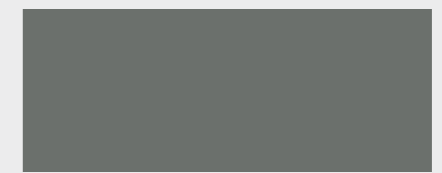

LACCATO FUMO

Tonalità calde
e desature si fondono
con uno spirito
metropolitano carico
di rimandi e significati.

*Warm and desaturated
colours come
together with an urban
spirit filled with references
and meanings.*

LIVING 07







Dettagli che raccontano una filosofia progettuale basata sul recupero e sulla valorizzazione dei materiali e delle loro caratteristiche peculiari. Si recupera, si rinnova, si trasforma.

Details narrating a design philosophy based on salvage and on the bringing out of the value of materials and their special features. Salvaging, renovating, transforming.

LIVING 07





Un nuovo sistema di pannellature a muro, caratterizzato dall'accostamento cromatico delle mensole in ferro e dei pannelli in legno, capace di adattarsi a molteplici spazi abitativi.

A new wall paneling system, characterized by the chromatic combination of iron shelves and wooden panels, suitable for multiple living spaces.



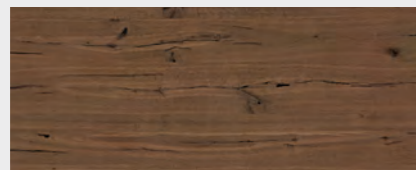
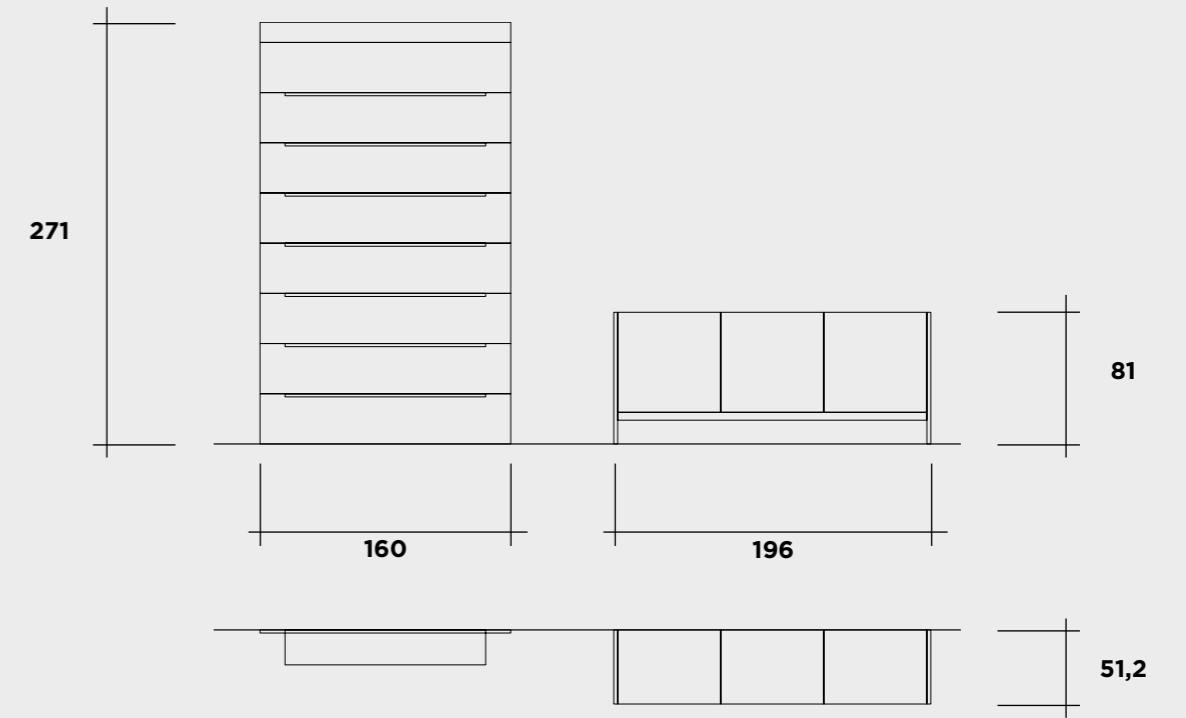
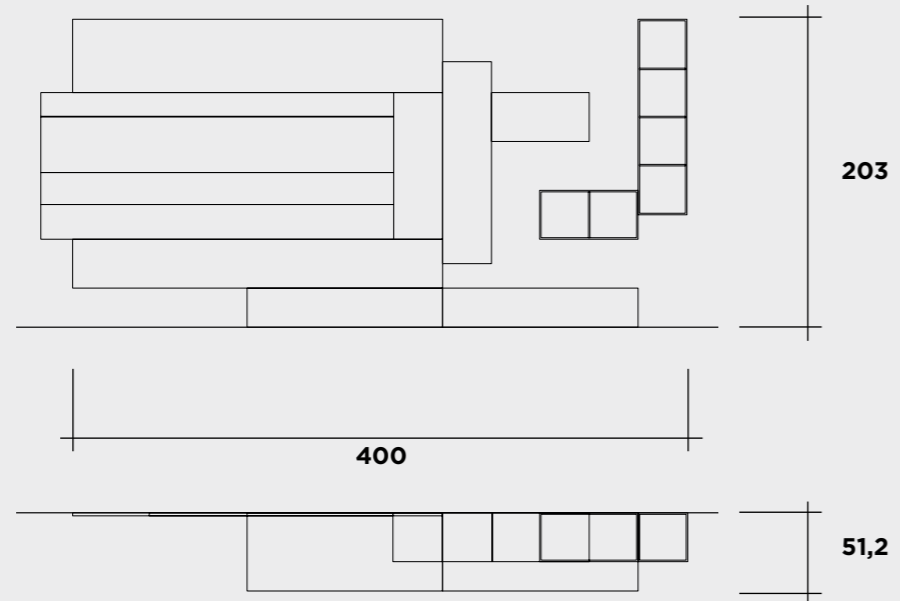

QUERCIA 100 N

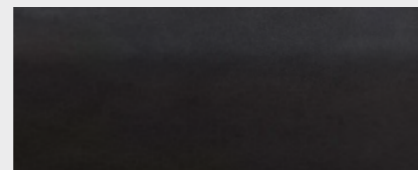

FERRO CERA



LACCATO SABBIA

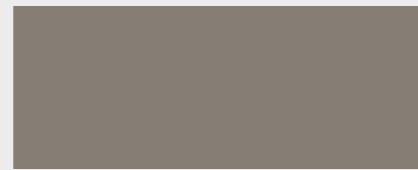

LACCATO VISONE

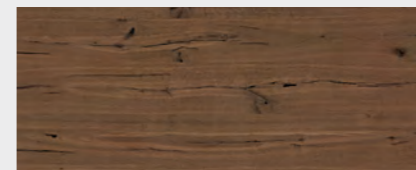

QUERCIA 100 N

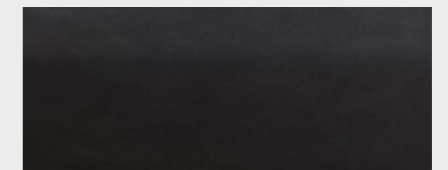

FERRO CERA



COMPACT CEMENTO

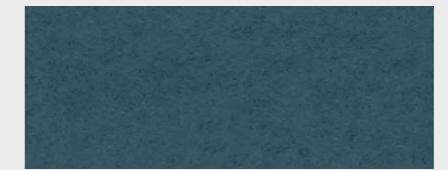

COMPACT BLU



Il progetto Rebel sa integrarsi ad ogni spazio, definendo nuovi spunti e nuove funzioni.

The Rebel design can be integrated in any space, defining new ideas and new functions.

LIVING

08





La finitura in pietra lavica e le sue sfaccettature uniche, si abbinano alle cromie eleganti in ogni composizione di living.

The lava stone finish and its unique facets, they match the elegant colors in every living room composition.

LIVING

08







Il dettaglio diventa sintesi di un linguaggio basato sulla purezza della forma e sulla solidità dell'idea progettuale.

The detail becomes the synthesis of an idiom based on clean lines and the solidity of the design idea.



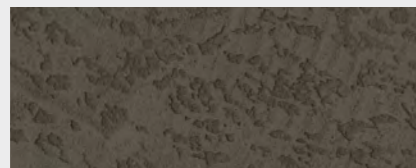
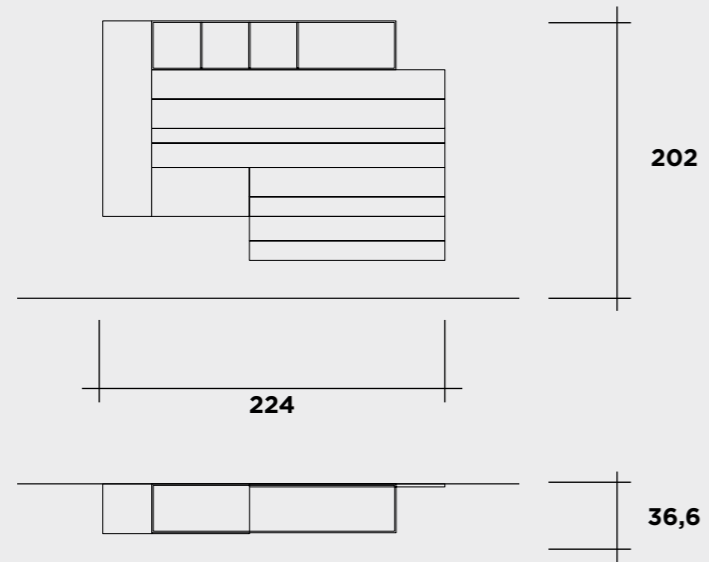

PIETRA LAVICA

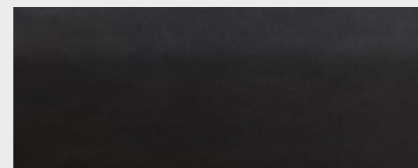

FERRO CERA



LACCATO VISONE

Una soluzione le cui cromie abbracciano la filosofia della collezione, riportando in primo piano il concetto di natura alternandosi in un gioco di pieni e vuoti.

A solution whose colours embrace the philosophy of the collection, bringing to the forefront the concept of nature alternating in a play on empty and solid.

LIVING 09







Un sistema giorno componibile basato sugli elementi contenitori e completato da boiserie e mensole. Una proposta originale, per progettare le soluzioni d'arredo della casa contemporanea.

A modular system based on storage elements and completed by boiserie and shelves. An original, extremely versatile offer to design contemporary home furnishing solutions.

LIVING 09





Un programma d'arredo dall'eccezionale versatilità. In costante evoluzione, si basa sulla pannellatura come centro estetico e funzionale del living e alleggerito dalla combinazione tra mensole, ante e contenitori.

A furnishing program with exceptional versatility. In constant evolution, it is based on paneling as an aesthetic and functional center of the living room and lightened by the combination of shelves, doors and containers.

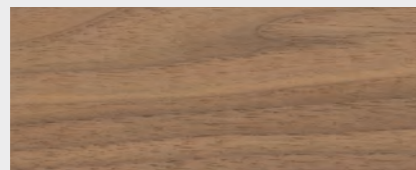
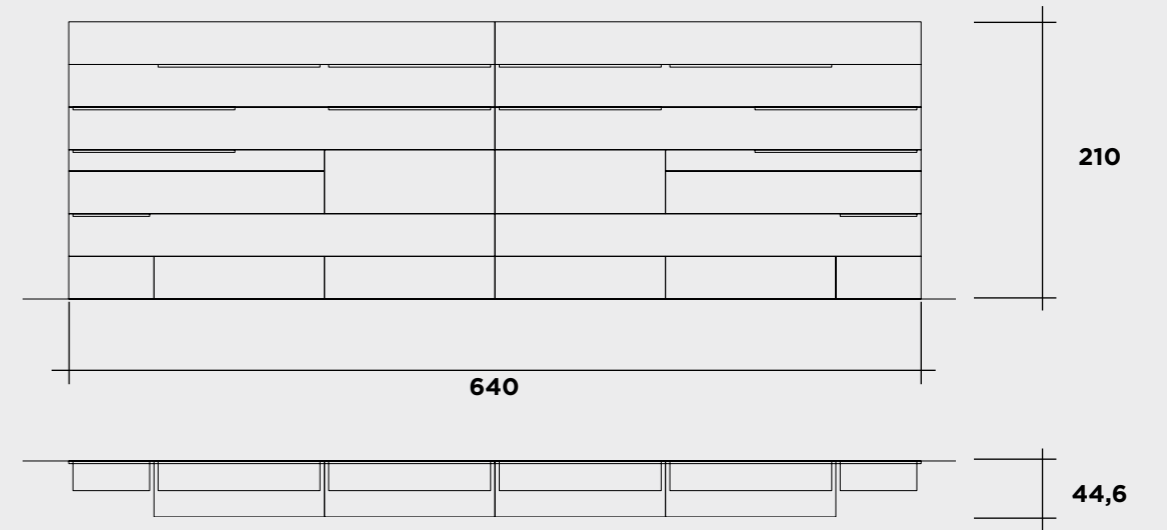
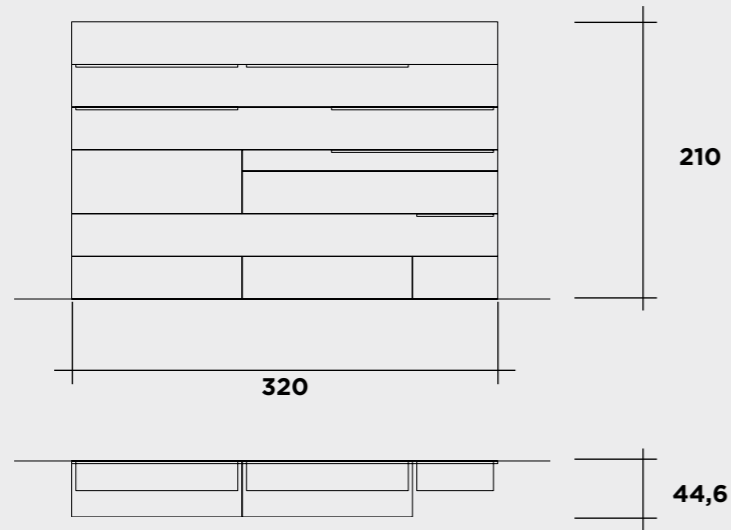

OLMO

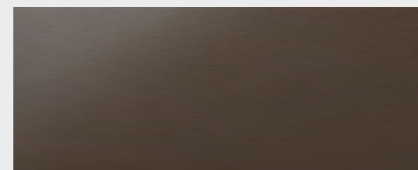

FERRO CERA

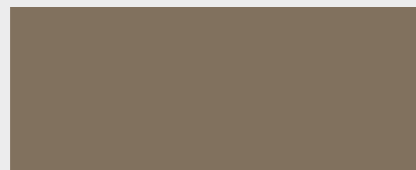

LACCATO TORTORA

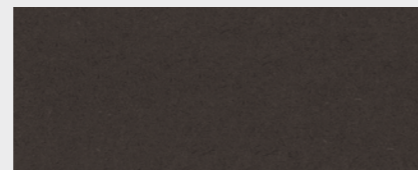

COMPACT TERRA

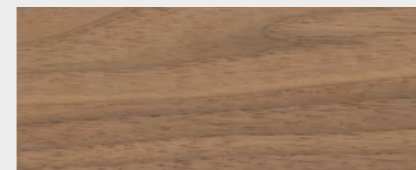

OLMO

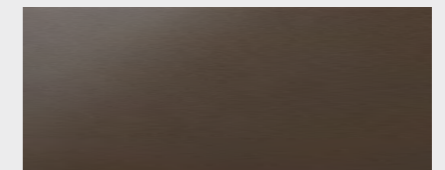

FERRO CERA

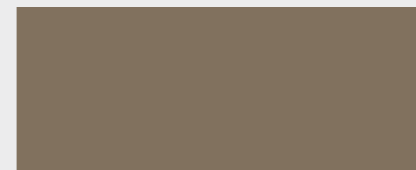

LACCATO TORTORA

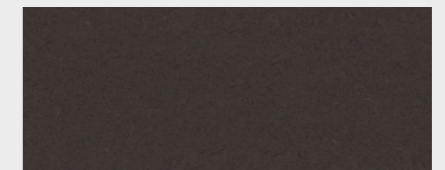

COMPACT TERRA

LACCATURE

- LACCATO OPACO
- LACCATO PORO APERTO
- LACCATO LUCIDO



Le tonalità dei colori qui riportati hanno valore puramente indicativo

LACCATURE



Le tonalità dei colori qui riportati hanno valore puramente indicativo

COMPACT

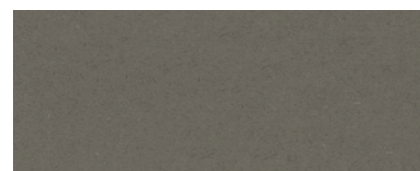

CEMENTO

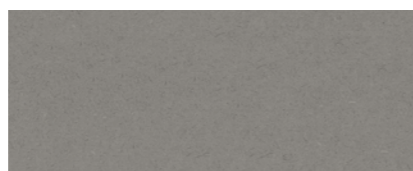

CENERE

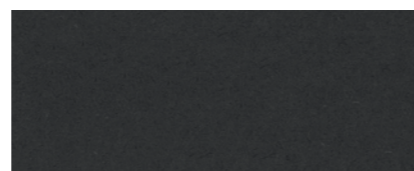

LAVAGNA



ROSSO



MATTONE

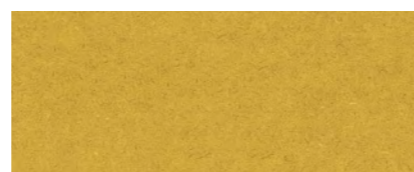

ZOLFO

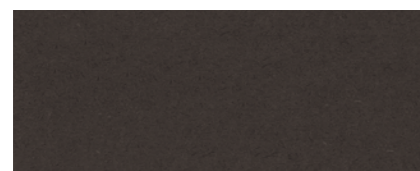

TERRA



VERDE BOSCO

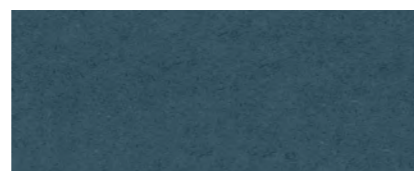

BLU

LACCATURE METALLICHE

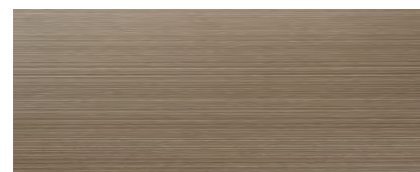

LACCATO METALLICO BRONZO



LACCATO METALLICO GRAFITE

FINITURE SPECIALI

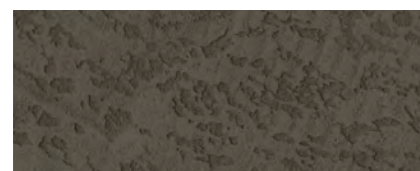

PIETRA LAVICA

Le tonalità dei colori qui riportati hanno valore puramente indicativo

ESSENZA 1

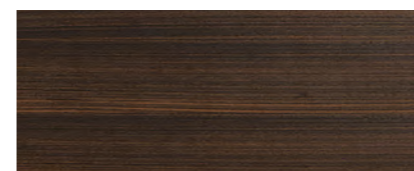

EUCALIPTO

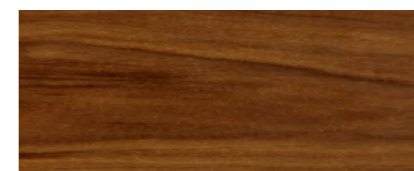

PALISSANDRO SANTOS

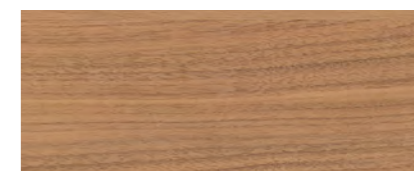

NOCE CANALETTO

ESSENZA 2

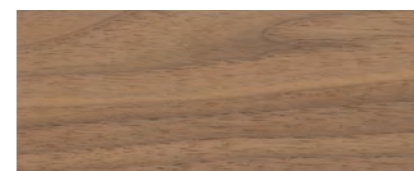

OLMO



OLMO PIOMBO



OLMO RAME

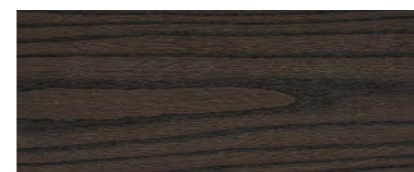

OLMO RUGGINE



OLMO ZINCO



OLMO LAVA



OLMO TITANIO



ROVERE GRIGIO



NOCE RANDOM



QUERCIA 25 S

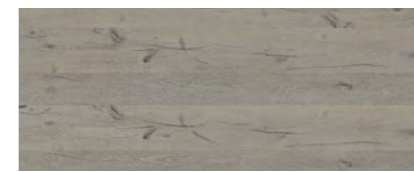

QUERCIA 50 C



QUERCIA 75 G

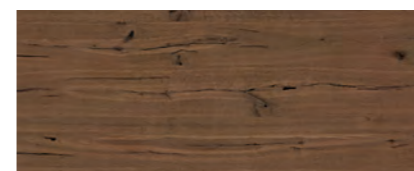

QUERCIA 100 N

Le tonalità dei colori qui riportati hanno valore puramente indicativo

Art Direction_
Sviluppo ambienti_

COLZANI & NOVATI

3D Illustration_

Neiko

Design_

Arch. Giulio Manzoni
Stream Studio

Sviluppo composizioni_

Arch. Tino Novati

Repro_
Print_

Grafiche Antiga
Grafiche Antiga
11/2021



FIMAR srl

via Valsorda Sp. 40
Z.I. Cremnago 22044
Inverigo (COMO)
T +39 031 698245

info@fimarmobili.com
www.fimarmobili.com



R
E
S
S